

DS 2001

Social Science Practicum

September 11, 2001

DS 2001

Physics

~~Social Science~~ Practicum

September 11, 2001

- Piazza
- Office hours

Post Type

Question

if you need an answer

Note

*if you **don't** need an answer*

Poll/In-Class Response

if you need a vote

Post to

Entire Class

Class Group

Individual Student(s) / Instructor(s)

Social Science

Select Folder(s)

hw1

hw2

hw3

hw4

hw5

hw6

hw7

hw8

hw9

hw10

project

exam

logistics

other

reading

health

Summary











(100 characters or less)

Enter a one line summary...

Details

use plain text editor

Edit ▾ Insert ▾ View ▾ Format ▾ Table ▾

B *I*          **fx** code tt markdown  Help

Posting Options

Send email notifications immediately (bypassing students' email preferences, if necessary)

Post My Note to DS 2000!

Save Draft

Cancel

Preview Post

Post Type

Question
if you need an answer

Note
*if you **don't** need an answer*

Poll/In-Class Response
if you need a vote

Post to

Entire Class Class Group Individual Student(s) / Instructor(s)

Social Science

Select Folder(s)

hw1 hw2 hw3 hw4 hw5 hw6 hw7 hw8 hw9 hw10 project exam logistics other reading health

Summary

(100 characters or less)

Enter a one line summary...

Details

use plain text editor

Edit ▾ Insert ▾ View ▾ Format ▾ Table ▾
B I [List Icons] [Link Icon] [Image Icon] [Media Icon] fx code tt markdown [Eye Icon] Help

Posting Options

Send email notifications immediately (bypassing students' email preferences, if necessary)

Post My Note to DS 2000!

Save Draft

Cancel

Preview Post

Post Type

Question

if you need an answer

Note

*if you **don't** need an answer*

Poll/In-Class Response

if you need a vote

Post to

Entire Class

Class Group

Individual Student(s) / Instructor(s)

Social Science

Select Folder(s)

hw1

hw2

hw3

hw4

hw5

hw6

hw7

hw8

hw9

hw10

project

exam

logistics

other

reading

health

Summary

(100 characters or less)

Enter a one line summary...

Details

use plain text editor

Edit ▾ Insert ▾ View ▾ Format ▾ Table ▾

B

I

☰

☰

↕

↕

☰

☰

🔗

🖼️

🔍

fx

code

tt

markdown

👁️

Help

Posting Options

Send email notifications immediately (bypassing students' email preferences, if necessary)

Post My Note to DS 2000!

Save Draft

Cancel

Preview Post

Post Type

Question
if you need an answer

Note
*if you **don't** need an answer*

Poll/In-Class Response
if you need a vote

Post to

Entire Class Class Group Individual Student(s) / Instructor(s)

Social Science

Select Folder(s)

hw1 hw2 hw3 hw4 hw5 hw6 hw7 hw8 hw9 hw10 project exam logistics other **reading** health

Summary

(100 characters or less)

Enter a one line summary...

Details

use plain text editor

Edit ▾ Insert ▾ View ▾ Format ▾ Table ▾

B *I* [List Icons] [Link Icon] [Image Icon] [Video Icon] **fx** code tt markdown [Eye Icon] Help

[Empty text area]

Posting Options

Send email notifications immediately (bypassing students' email preferences, if necessary)

Post My Note to DS 2000!

Save Draft

Cancel

Preview Post

Office Hours

Section 1

Carolina Mattsson
Tuesdays 9:30–11:30
West Village H 164

Sarthak Bahndari
TBD

Section 2

Stefan McCabe
Tuesdays 3:00–5:00
1029I 177 Huntington
(email beforehand)

Romil Rathi
Mondays 2:00–4:00
WVH 3rd floor
Thursdays 5:00–7:00
KA 708

$$-u^2) \frac{\partial u}{\partial x} - uv \left(\frac{\partial u}{\partial y} + \frac{\partial v}{\partial x} \right) \\ + (a^2 - v^2) \frac{\partial v}{\partial y} + \frac{a^2}{\partial} v$$

THESE EQUATIONS

SPACE

COMPONENTS

COMP

THE

PRESS

DENSI

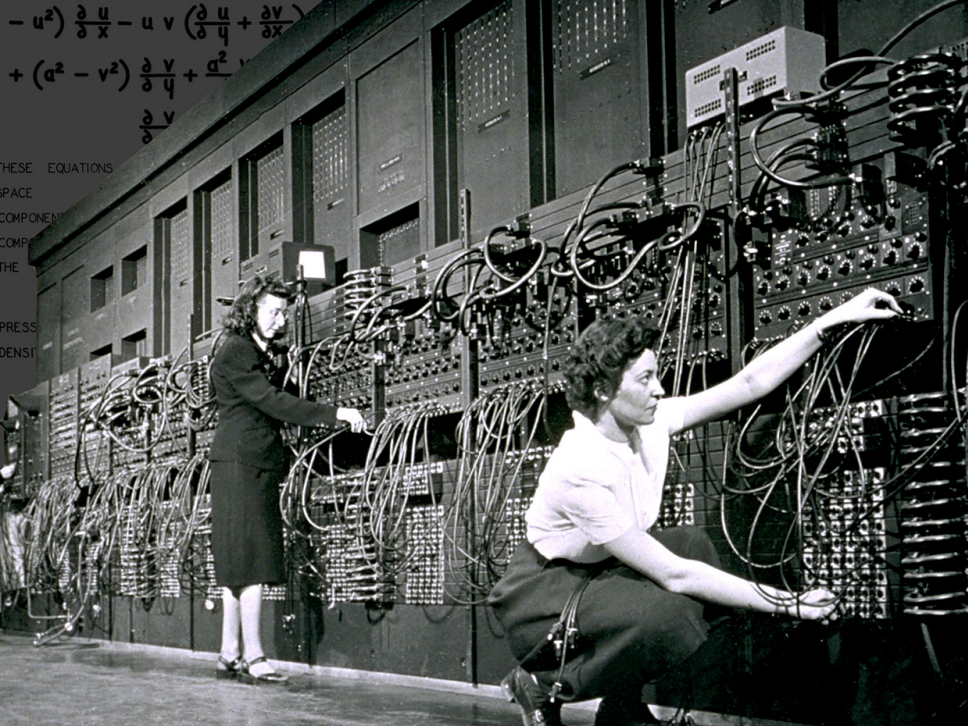

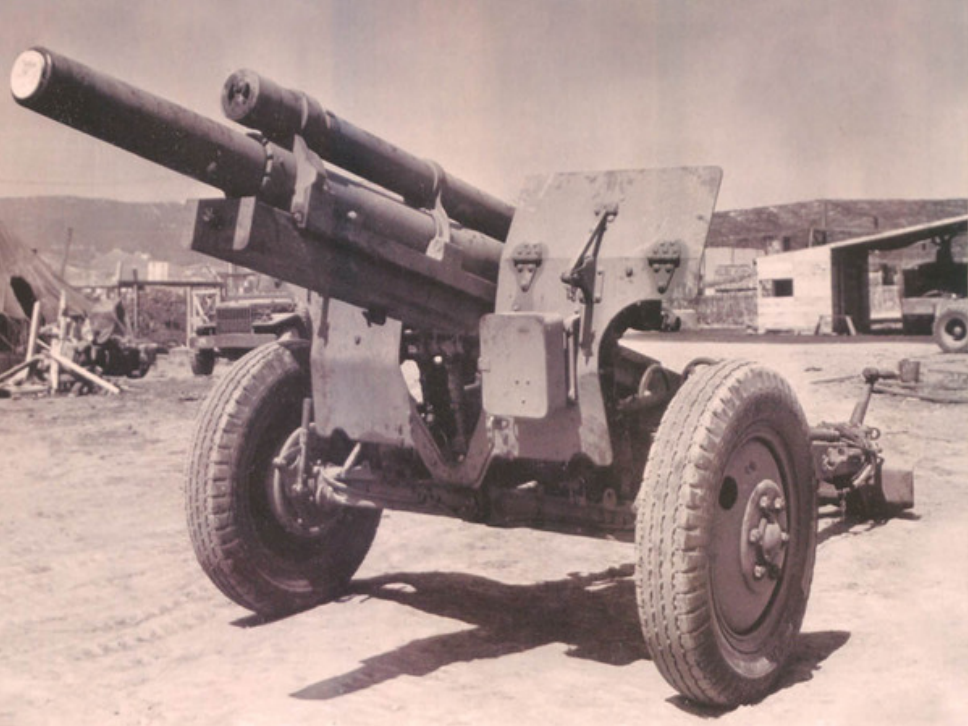

PHYSICAL PROPERTIES

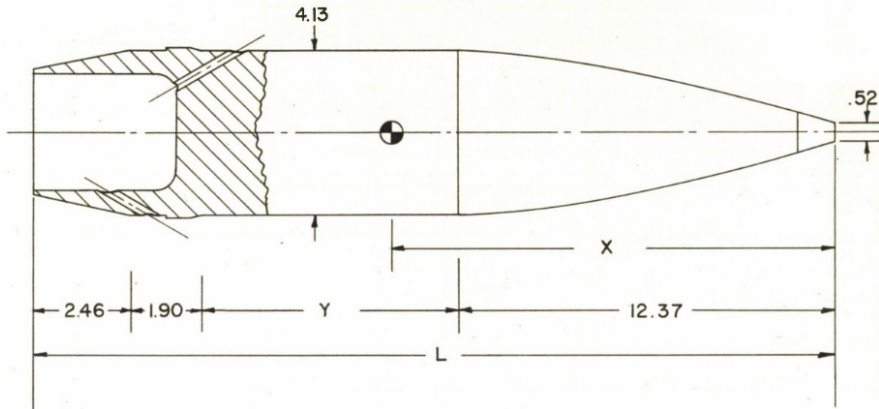

TYPE	WT (LBS)	A (LBS-IN ²)	B (LBS-IN ²)	X CM(IN)	L (IN)	Y
1	29.07	72.60	919.0	13.78	23.22	6.49
2	28.76	71.40	892.0	13.59	23.00	6.27
3	29.20	72.60	885.7	13.45	22.84	6.11
4	29.08	72.27	861.0	13.29	22.63	5.90

ZERO-YAW DRAG COEFFICIENT
 VS
 MACH NUMBER

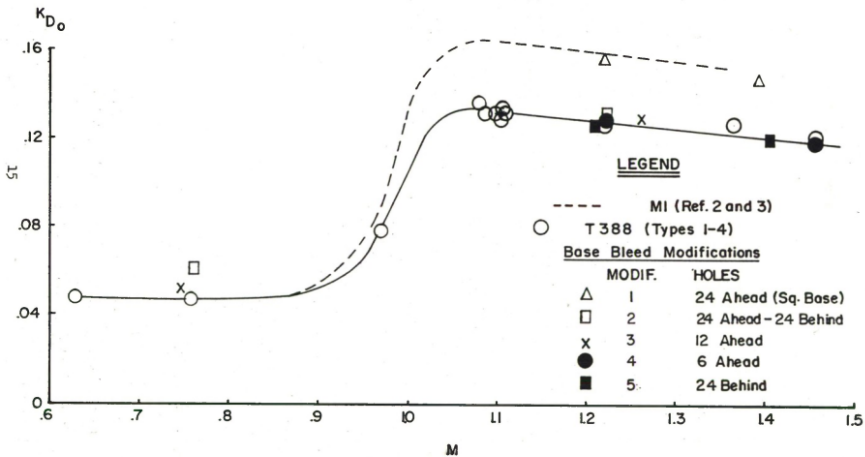

FIG. 2

Formulae and Constants

1 foot = 0.3048 meters

$$A = \pi \left(\frac{d}{2} \right)^2$$

$$v_t = \sqrt{\frac{2mg}{\rho A C_d}}$$

$$x_t = \frac{v_t}{g} (v_i \cos(\theta)) \left(1 - e^{-\frac{gt}{v_t}} \right)$$

$$y_t = \frac{v_t}{g} (v_i \sin(\theta) + v_t) \left(1 - e^{-\frac{gt}{v_t}} \right) - v_t t$$

$$v_i = 875 \text{ ft/s}$$

$$\pi = 3.1415926536$$

$$d = 105 \text{ mm}$$

$$m = 13.19 \text{ kg}$$

$$C_d = 0.0494$$

$$e = 2.718281828$$

$$\rho = 1.225 \text{ kg/m}^3$$

$$g = 9.8 \text{ m/s}^2$$